



HIT-HY 170 INJECTION MORTAR

Technical Datasheet

Update: Mar-20





HIT-HY 170 injection mortar

Anchor design (EN 1992-4) / Rods&Sleeves / Concrete

Injection mortar system



Hilti HIT-HY 170

500 ml foil pack
(also available as
330 ml foil pack)



Anchor rod:
HAS-U
HAS-U HDG
HAS-U A4
HAS-U HCR
(M8-M24)



Internally
threaded sleeve:
HIS-N
HIS-RN
(M8-M16)

Benefits

- Suitable for non-cracked and cracked ^{a)} concrete C 20/25 to C 50/60.
- Suitable for dry and water saturated concrete.
- Small edge distance and anchor spacing possible.
- High corrosion / corrosion resistant.
- In service temperature range up to 80°C short term / 50°C long term.

a) Applications only with HAS-U anchor rods.

Base material



Concrete
(non-cracked)



Concrete
(cracked) ^{a)}

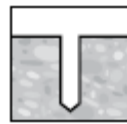

Dry concrete



Wet
concrete

Load conditions

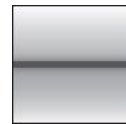

Static/
quasi-static



Seismic,
ETA-C2

Installation conditions

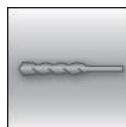

Hammer
drilled holes

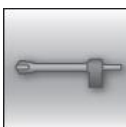

Hollow drill-
bit drilling



Small edge
embedment
depth

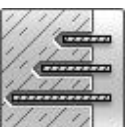

Variable
embedment
depth

Other information



European
Technical
Assessment



CE
conformity

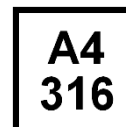

Corrosion
resistance



High
corrosion
resistance ^{a)}

a) Applications only with HAS-U anchor rods.

Approvals / certificates

Description	Authority / Laboratory	No. / date of issue
European technical Approval ^{a)}	DIBt, Berlin, Germany	ETA-19/0465 / 2019-08-28
European technical Approval ^{b)}	DIBt, Berlin, Germany	ETA-14/0457 / 2017-12-14

a) All data given in this section according to ETA-19/0465, issue 2019-08-28.

b) All data given in this section according to ETA-14/0457, issue 2017-12-14.

Basic loading data (for a single anchor)

All data in this section applies to:

- Correct setting (See setting instruction)
- No edge distance and spacing influence
- Steel failure
- Base material thickness as specified in the table
- One typical embedment depth, as specified in the table
- One anchor material, as specified in the tables
- Concrete C 20/25, $f_{ck,cube} = 25 \text{ N/mm}^2$
- Temperature range I (min. base material temp. -40°C , max. long/short term base material temp.: $+24^\circ\text{C}/40^\circ\text{C}$)

Embedment depth ^{a)}

Anchor size			M8	M10	M12	M16	M20	M24
HAS-U								
Embedment depth	h_{ef}	[mm]	80	90	110	125	170	210
Base material thickness	h	[mm]	110	120	140	160	220	270
HIS-N								
Embedment depth	h_{ef}	[mm]	90	110	125	170	-	-
Base material thickness	h	[mm]	120	150	170	230	-	-

a) The allowed range of embedment depth is shown in the setting details.

For hammer drilled holes, hammer drilled holes with Hilti hollow drill bit:

Characteristic resistance

Anchor size			M8	M10	M12	M16	M20	M24
Non-cracked concrete								
Tension N_{Rk}	HAS-U 5.8	[kN]	18,0	28,3	41,5	62,8	106,8	158,3
	HAS-U 8.8		20,1	28,3	41,5	62,8	106,8	158,3
	HAS-U A4		20,1	28,3	41,5	62,8	106,8	158,3
	HAS-U HCR		20,1	28,3	41,5	62,8	106,8	158,3
	HIS-N 8.8		25	46,0	67,0	121,9	-	-
Shear V_{Rk}	HAS-U 5.8	[kN]	9,0	15,0	21,0	39,0	61,0	88,0
	HAS-U 8.8		15,0	23,0	34,0	63,0	98,0	141
	HAS-U A4		13,0	20,0	30,0	55,0	86,0	124
	HAS-U HCR		15,0	23,0	34,0	63,0	98,0	124
	HIS-N 8.8		13,0	23,0	34,0	63,0	-	-
Cracked concrete								
Tension N_{Rk}	HAS-U 5.8	[kN]	-	15,6	22,8	34,6	-	-
	HAS-U 8.8		-	15,6	22,8	34,6	-	-
	HAS-U A4		-	15,6	22,8	34,6	-	-
	HAS-U HCR		-	15,6	22,8	34,6	-	-
Shear V_{Rk}	HAS-U 5.8	[kN]	-	15,0	21,0	39,0	-	-
	HAS-U 8.8		-	23,0	34,0	63,0	-	-
	HAS-U A4		-	20,0	30,0	55,0	-	-
	HAS-U HCR		-	23,0	34,0	63,0	-	-

Design resistance

Anchor size		M8	M10	M12	M16	M20	M24
Non-cracked concrete							
Tension N_{Rd}	HAS-U 5.8	12,0	18,8	27,6	41,9	71,2	99,8
	HAS-U 8.8	13,4	18,8	27,6	41,9	71,2	99,8
	HAS-U A4	13,4	18,8	27,6	41,9	71,2	99,8
	HAS-U HCR	13,4	18,8	27,6	41,9	71,2	99,8
	HIS-N 8.8	16,7	30,7	44,7	72,7	-	-
Shear V_{Rd}	HAS-U 5.8	7,2	12,0	16,8	31,2	48,8	70,4
	HAS-U 8.8	12,0	18,4	27,2	50,4	78,4	112,8
	HAS-U A4	8,3	12,8	19,2	35,3	55,1	79,5
	HAS-U HCR	12,0	18,4	27,2	50,4	78,4	70,9
	HIS-N 8.8	10,4	18,4	27,2	50,4	-	-
Cracked concrete							
Tension N_{Rd}	HAS-U 5.8	-	10,4	15,2	23,0	-	-
	HAS-U 8.8	-	10,4	15,2	23,0	-	-
	HAS-U A4	-	10,4	15,2	23,0	-	-
	HAS-U HCR	-	10,4	15,2	23,0	-	-
Shear V_{Rd}	HAS-U 5.8	-	12,0	16,8	31,2	-	-
	HAS-U 8.8	-	18,4	27,2	46,1	-	-
	HAS-U A4	-	12,8	19,2	35,3	-	-
	HAS-U HCR	-	18,4	27,2	46,1	-	-

Recommended loads ^{a)}

Anchor size		M8	M10	M12	M16	M20	M24
Non-cracked concrete							
Tension N_{Rec}	HAS-U 5.8	8,6	13,5	19,7	29,9	50,9	71,3
	HAS-U 8.8	9,6	13,5	19,7	29,9	50,9	71,3
	HAS-U A4	9,6	13,5	19,7	29,9	50,9	71,3
	HAS-U HCR	9,6	13,5	19,7	29,9	50,9	71,3
	HIS-N 8.8	11,9	21,9	31,9	51,9	-	-
Shear V_{Rec}	HAS-U 5.8	5,1	8,6	12,0	22,3	34,9	50,3
	HAS-U 8.8	8,6	13,1	19,4	36,0	56,0	80,6
	HAS-U A4	6,0	9,2	13,7	25,2	39,4	56,8
	HAS-U HCR	8,6	13,1	19,4	36,0	56,0	50,6
	HIS-N 8.8	7,4	13,1	19,4	36,0	-	-
Cracked concrete							
Tension N_{Rec}	HAS-U 5.8	-	7,4	10,9	16,5	-	-
	HAS-U 8.8	-	7,4	10,9	16,5	-	-
	HAS-U A4	-	7,4	10,9	16,5	-	-
	HAS-U HCR	-	7,4	10,9	16,5	-	-
Shear V_{Rec}	HAS-U 5.8	-	8,6	12,0	22,3	-	-
	HAS-U 8.8	-	13,1	19,4	32,9	-	-
	HAS-U A4	-	9,2	13,7	25,2	-	-
	HAS-U HCR	-	13,1	19,4	32,9	-	-

a) With overall partial safety factor for action $\gamma=1,4$. The partial safety factors for action depend on the type of loading and shall be taken from national regulations.

Seismic resistance

All data in this section applies to:

- Hammer drilled holes and hammer drilled holes with hollow drill bit
- Correct setting (See setting instructions)
- No edge distance and spacing influence
- *Steel* failure
- Minimum base material thickness
- Concrete C20/25, $f_{ck,cube} = 25 \text{ N/mm}^2$
- $\alpha_{gap} = 1,0$ (using Hilti seismic filling set)
- Temperature range I: -40 °C to +40 °C
(max. long term temperature +24 °C and max. short term temperature +40 °C)

Embedment depth and base material thickness for seismic C2

Anchor size		M8	M10	M12	M16	M20	M24
HAS-U							
Eff. Anchorage depth	[mm]	80	90	110	125	170	210
Base material thickness	[mm]	110	120	140	160	220	270

For hammer drilled holes and hollow drill bit:

Characteristic resistance in case of seismic performance category C2

Anchor size		M8	M10	M12	M16	M20	M24
Tensile N_{Rk}	HAS-U 8.8, AM 8.8 [kN]	-	-	8,3	11,9	-	-
Shear V_{Rk}	HAS-U 8.8, AM 8.8 w/ filling set [kN]	-	-	28,0	46,0	-	-
	HAS-U 8.8, AM 8.8 w/o filling set [kN]	-	-	24,0	40,0	-	-

Design resistance in case of seismic performance category C2

Anchor size		M8	M10	M12	M16	M20	M24
Tensile N_{Rd}	HAS-U 8.8, AM 8.8 [kN]	-	-	5,5	8,0	-	-
Shear V_{Rd}	HAS-U 8.8, AM 8.8 w/ filling set [kN]	-	-	22,4	36,8	-	-
	HAS-U 8.8, AM 8.8 w/o filling set [kN]	-	-	19,2	32,0	-	-

Materials

Materials properties for HAS-U

Anchor size		M8	M10	M12	M16	M20	M24
Nominal tensile strength f_{uk}	HAS-U 5.8	500	500	500	500	500	500
	HAS-U 8.8	800	800	800	800	800	800
	HAS-U A4	700	700	700	700	700	700
	HAS-U HCR	800	800	800	800	800	700
Yield strength f_{yk}	HAS-U 5.8	400	400	400	400	400	400
	HAS-U 8.8	640	640	640	640	640	640
	HAS-U A4	450	450	450	450	450	450
	HAS-U HCR	640	640	640	640	640	400
Stressed cross-section A_s	HAS-U [mm ²]	36,6	58,0	84,3	157	245	353
Moment of resistance W	HAS-U [mm ³]	31,2	62,3	109	277	541	935

Mechanical properties for HIS-N

Anchor size		M8	M10	M12	M16
Nominal tensile strength f_{uk}	HIS-N	490	490	490	490
	Screw 8.8	800	800	800	800
	HIS-RN	700	700	700	700
	Screw A4-70	700	700	700	700
Yield strength f_{yk}	HIS-N	390	390	390	390
	Screw 8.8	640	640	640	640
	HIS-RN	350	350	350	350
	Screw A4-70	450	450	450	450
Stressed cross-section A_s	HIS-(R)N [mm ²]	51,5	108,0	169,1	256,1
	Screw	36,6	58	84,3	157
Moment of resistance W	HIS-(R)N [mm ³]	145	430	840	1595
	Screw	31,2	62,3	109	277

Material quality for HAS-U

Part	Material
Zinc coated steel	
Threaded rod, HAS-U 5.8 (HDG)	Strength class 5.8; Elongation at fracture A5 > 8% ductile Electroplated zinc coated $\geq 5\mu\text{m}$; (HDG) hot dip galvanized $\geq 45\mu\text{m}$
Threaded rod, HAS-U 8.8 (HDG)	Strength class 8.8; Elongation at fracture A5 > 12% ductile Electroplated zinc coated $\geq 5\mu\text{m}$; (HDG) hot dip galvanized $\geq 45\mu\text{m}$
Hilti Meter rod, AM 8.8 (HDG)	Strength class 8.8; Elongation at fracture A5 > 12% ductile Electroplated zinc coated $\geq 5\mu\text{m}$ (HDG) hot dip galvanized $\geq 45\mu\text{m}$
Washer	Electroplated zinc coated $\geq 5\mu\text{m}$, hot dip galvanized $\geq 45\mu\text{m}$
Nut	Strength class of nut adapted to strength class of threaded rod. Electroplated zinc coated $\geq 5\mu\text{m}$, hot dip galvanized $\geq 45\mu\text{m}$
Hilti Filling set (F)	Filling washer: Electroplated zinc coated $\geq 5\mu\text{m}$, (F) hot dip galvanized $\geq 45\mu\text{m}$ Spherical washer: Electroplated zinc coated $\geq 5\mu\text{m}$, (F) hot dip galvanized $\geq 45\mu\text{m}$ Lock nut: Electroplated zinc coated $\geq 5\mu\text{m}$, (F) hot dip galvanized $\geq 45\mu\text{m}$
Stainless Steel	
Threaded rod, HAS-U A4	Strength class 70 for $\leq M24$ and strength class 50 for $> M24$; Elongation at fracture A5 > 8% ductile Stainless steel 1.4401; 1.4404; 1.4578; 1.4571; 1.4439; 1.4362
Washer	Stainless steel 1.4401, 1.4404, 1.4578, 1.4571, 1.4439, 1.4362 EN 10088-1:2014
Nut	Stainless steel 1.4401, 1.4404, 1.4578, 1.4571, 1.4439, 1.4362 EN 10088-1:2014
High corrosion resistant steel	
Threaded rod, HAS-U HCR	Strength class 80 for $\leq M20$ and class 70 for $> M20$, Elongation at fracture A5 > 8% ductile High corrosion resistance steel 1.4529; 1.4565;
Washer	High corrosion resistant steel 1.4529, 1.4565 EN 10088-1:2014
Nut	High corrosion resistant steel 1.4529, 1.4565 EN 10088-1:2014

Material quality for HIS-N

Part	Material	
HIS-N	Internal threaded sleeve	C-steel 1.0718 / Steel galvanized $\geq 5\mu\text{m}$
	Screw 8.8	Strength class 8.8, A5 > 8 % Ductile / Steel galvanized $\geq 5\mu\text{m}$
HIS-RN	Internal threaded sleeve	Stainless steel 1.4401, 1.4571
	Screw 70	Strength class 70, A5 > 8 % Ductile Stainless steel 1.4401; 1.4404, 1.4578; 1.4571; 1.4439; 1.4362

Setting information

Installation temperature range

-5°C to +40°C

In service temperature range

Hilti HIT-HY 170 injection mortar with anchor rod HIT-V may be applied in the temperature ranges given below. An elevated base material temperature leads to a reduction of the design bond resistance.

Temperature in the base material

Temperature range	Base material temperature	Maximum long term base material temperature	Maximum short term base material temperature
Temperature range I	-40 °C to +40 °C	+24 °C	+40 °C
Temperature range II	-40 °C to +80 °C	+50 °C	+80 °C

Max short term base material temperature

Short-term elevated base material temperatures are those that occur over brief intervals, e.g. as a result of diurnal cycling.

Max long term base material temperature

Long-term elevated base material temperatures are roughly constant over significant periods of time.

Curing and working time ^{a)}

Temperature of the base material	Maximum working time t_{work}	Maximum curing time t_{cure}
$-5\text{ °C} \leq T_{BM} \leq 0\text{ °C}$ ^{a)}	10 min	12 hours
$0\text{ °C} \leq T_{BM} \leq 5\text{ °C}$ ^{a)}	10 min	5 hours
$5\text{ °C} \leq T_{BM} \leq 10\text{ °C}$	8 min	2,5 hours
$10\text{ °C} \leq T_{BM} \leq 20\text{ °C}$	5 min	1,5 hours
$20\text{ °C} \leq T_{BM} \leq 30\text{ °C}$	3 min	45 min
$30\text{ °C} \leq T_{BM} \leq 40\text{ °C}$	2 min	30 min

a) The curing time data are valid for dry base material only. In wet base material the curing times must be doubled.

Setting details for HAS-U

Anchor size		M8	M10	M12	M16	M20	M24
Nominal diameter of drill bit	d_0 [mm]	10	12	14	18	22	28
Diameter of the element	d [mm]	8	10	12	16	20	24
Eff. embedment depth and drill hole depth ^{a)}	$h_{ef,min}$ [mm]	60	60	70	80	90	96
	$h_{ef,ma}$ [mm]	96	120	144	192	240	288
Min. base material thickness	h_{min} [mm]	$h_{ef} + 30 \text{ mm} \geq 100 \text{ mm}$			$h_{ef} + 2 d_0$		
Max. diameter of clearance hole in the fixture	d_f [mm]	9	12	14	18	22	26
Max. torque moment ^{b)}	T_{max} [Nm]	10	20	40	80	150	200
Min. spacing	s_{min} [mm]	40	50	60	75	90	115
Min. edge distance	c_{min} [mm]	40	45	45	50	55	60
Critical spacing for splitting failure	$s_{cr,sp}$ [mm]	$2 c_{cr,sp}$					
Critical edge distance for splitting failure ^{c)}	$c_{cr,sp}$ [mm]	$1,0 \cdot h_{ef}$ for $h / h_{ef} \geq 2,00$					
		$4,6 h_{ef} - 1,8 h$ for $2,00 > h / h_{ef} > 1,3$					
		$2,26 h_{ef}$ for $h / h_{ef} \leq 1,3$					
Critical spacing for concrete cone failure	$s_{cr,N}$ [mm]	$2 c_{cr,sp}$					
Critical edge distance for concrete cone failure ^{d)}	$c_{cr,N}$ [mm]	$1,5 h_{ef}$					

For spacing (edge distance) smaller than critical spacing (critical edge distance) the design loads have to be reduced. $h_{ef,min} \leq h_{ef} \leq h_{ef,max}$ (h_{ef} : embedment depth)

- a) Maximum recommended torque moment to avoid splitting failure during instalation with minimum spacing and edge distance
- b) h : base material thickness ($h \geq h_{min}$)
- c) The critical edge distance for concrete cone failure depends on the embedment depth h_{ef} and the design bond resistance. The simplified formula given in this table is on the save side.

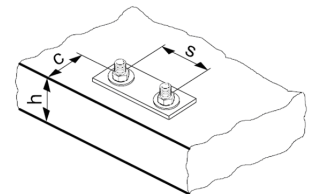

HAS-U...

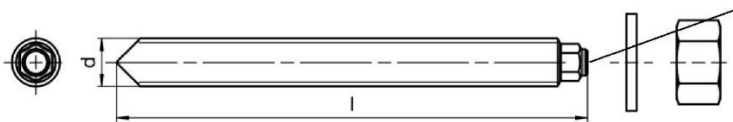

Marking:

Steel grade number and length identification letter: e.g. 8L

AM 8.8



Setting details for HIS-N

Anchor size		M8	M10	M12	M16
Nominal diameter of drill bit	d_0 [mm]	14	18	22	28
Diameter of element	d [mm]	12,5	16,5	20,5	25,4
Eff. embedment depth and drill hole depth ^{a)}	h_{ef} [mm]	90	110	125	170
	h_{min} [mm]	120	150	170	230
Diameter of clearance hole in the fixture	d_f [mm]	9	12	14	18
Thread engagement length min-max	h_s [mm]	8-20	10-25	12-30	16-40
Min. spacing	s_{min} [mm]	60	75	90	115
Min. edge distance	c_{min} [mm]	40	45	55	65
Critical spacing for splitting failure	$s_{cr,sp}$ [mm]	$2 c_{cr,sp}$			
Critical edge distance for splitting failure ^{a)}	$c_{cr,sp}$ [mm]	$1,0 \cdot h_{ef}$ for $h / h_{ef} \geq 2,0$			
		$4,6 h_{ef} - 1,8 h$ for $2,0 > h / h_{ef} > 1,3$			
		$2,26 h_{ef}$ for $h / h_{ef} \leq 1,3$			
Critical spacing for concrete cone failure	$s_{cr,N}$ [mm]	$2 c_{cr,N}$			
Critical edge distance for concrete cone failure ^{b)}	$c_{cr,N}$ [mm]	$1,5 h_{ef}$			
Torque moment ^{c)}	T_{max} [Nm]	10	20	40	80

For spacing (edge distance) smaller than critical spacing (critical edge distance) the design loads have to be reduced.

- a) h : base material thickness ($h \geq h_{min}$), h_{ef} : embedment depth
- b) The critical edge distance for concrete cone failure depends on the embedment depth h_{ef} and the design bond resistance. The simplified formula given in this table is on the safe side.
- c) Maximum recommended torque moment to avoid splitting failure during installation with minimum spacing and/or edge distance.

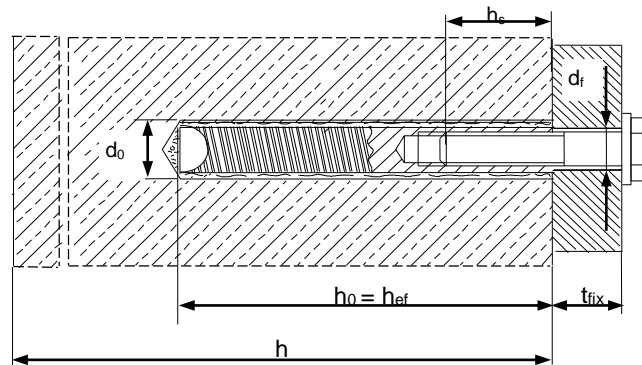

Installation equipment

Anchor size		M8	M10	M12	M16	M20	M24
Rotary hammer	HIT-V	TE 2 (-A) – TE 30 (-A)				TE 40 - TE 80	
	HIS-N	TE 2 (-A) – TE 30 (-A)		TE 40 - TE 80		-	
Other tools		compressed air gun and blow out pump, set of cleaning brushes, dispenser					

Drilling and cleaning parameters

HAS-U	HIS-N	Drill bit diameters d_0 [mm]		Installation size [mm]	
		Hammer drill (HD)	Hollow Drill Bit (HDD)	Brush HIT-RB	Piston plug HIT-SZ
M8	-	10	-	10	-
M10	-	12	-	12	12
M12	M8	14	14	14	14
M16	M10	18	18	18	18
M20	M12	22	22	22	22
M24	M16	28	28	28	28

Setting instructions

*For detailed information on installation see instruction for use given with the package of the product



Safety regulations.

Review the Material Safety Data Sheet (MSDS) before use for proper and safe handling! Wear well-fitting protective goggles and protective gloves when working with Hilti HIT-HY 170.

Drilling

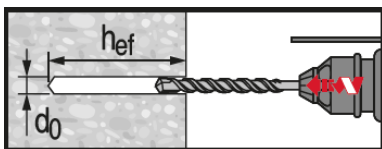

Hammer drilled hole

For dry and wet concrete.

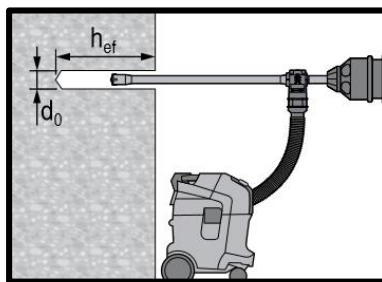

Hammer drilled hole with Hollow Drilled Bit (HDB)

No cleaning required.

Cleaning

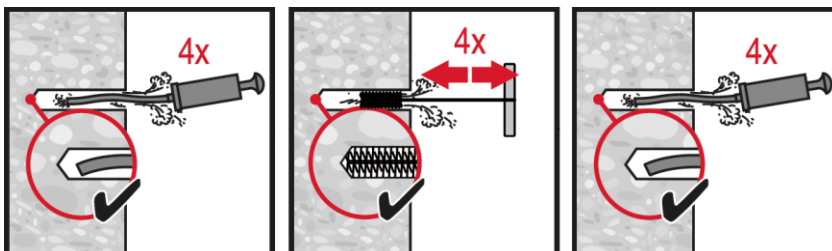

Manual cleaning (MC)

Non-cracked concrete only
for drill diameters $d_0 \leq 18$ mm and drill hole depth $h_0 \leq 10 \cdot d_0$.

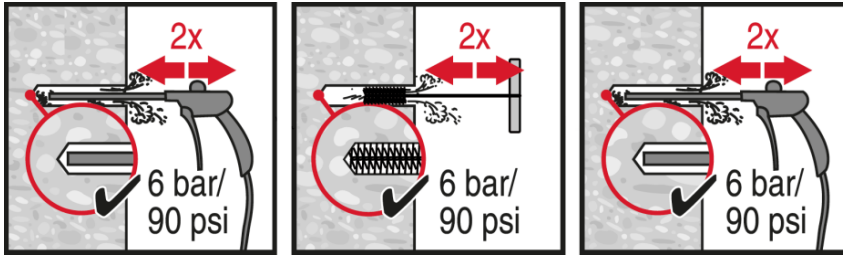

Compressed air cleaning (CAC)
for all drill hole diameters d_0 and drill hole depths h_0 .

Injection

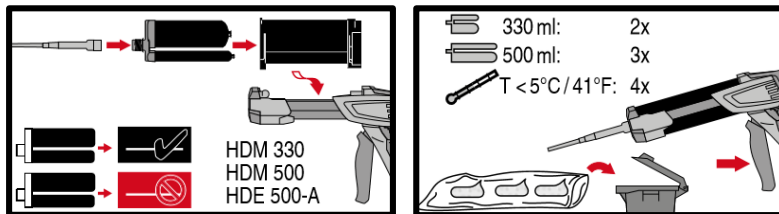

Injection system preparation.

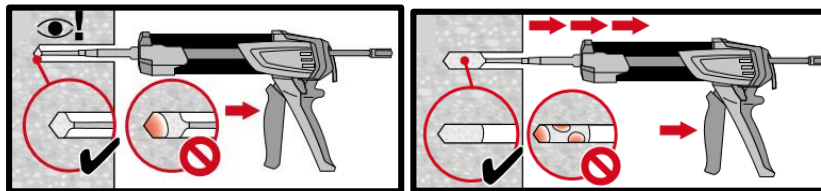

Injection method for drill hole

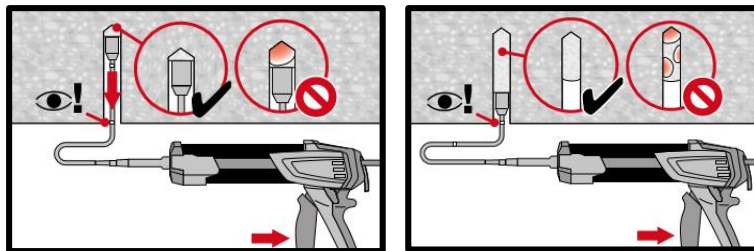

Injection method for overhead application and/or installation with embedment depth $h_{ef} > 250$ mm.

Setting the element

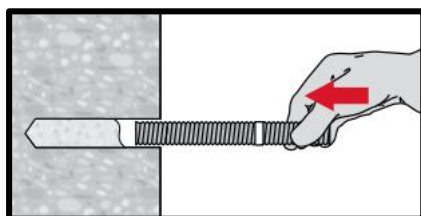

Setting element, observe working time " t_{work} ".

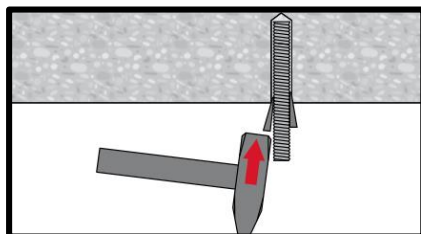

Setting element for overhead applications

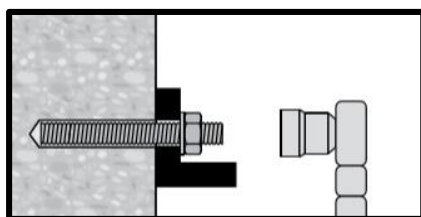

Loading the anchor after required curing time t_{cure}



HIT-HY 170 injection mortar

Anchor design (ETAG 029) / Rods&Sleeves / Masonry

Injection mortar system Benefits



Hilti HIT-HY 170
500 ml foil pack
(also available as
330 ml foil pack)

- Chemical injection fastening for the most common types of base materials:
- Hollow and solid clay bricks, calcium silicate bricks, normal and light weight concrete blocks
- Two-component hybrid mortar
- Versatile and convenient handling with HDE dispenser
- Mortar filing control with HIT-SC sleeves



Anchor rod:
HIT-V
HIT-V-F
HIT-V-R
HIT-V-HCR
(M8-M12)



Internally threaded sleeve:
HIT-IC
(M8-M12)

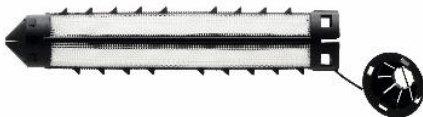

HIT-SC
sieve sleeve
(16-22)

Base material Load conditions

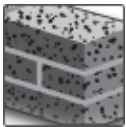

Solid brick

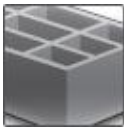

Hollow brick

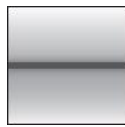

Static/
quasi-static

Installation conditions Other information



Hammer drilled holes

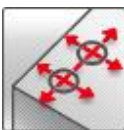

Small edge embedment depth



Variable embedment depth



European Technical Assessment



CE conformity

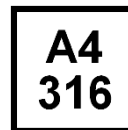

Corrosion resistance



High corrosion resistance



PROFIS Anchor design software

Approvals / certificates

Description	Authority / Laboratory	No. / date of issue
European technical Approval ^{a)}	DIBt, Berlin, Germany	ETA-15/0197 / 2015-12-09

c) All data given in this section according to ETA-15/0197, issue 2015-12-09.

Brick types and properties

Instruction to this technical data

- Identify/choose your brick (or brick type) and its geometrical/physical properties on the following tables. Information about edge and spacing criteria for every brick is available on page 4.
- The pages referred on the last column of the table below contain the design resistance loads for pull-out failure of the anchor, brick breakout failure and local brick failure for each respective brick. Notice that the data displayed on these tables is only valid for single anchors with distance to edge equal to or greater than c_{cr} – for other cases not covered, use PROFIS Anchor software, consult ETA-15/0197 or contact Hilti Engineering Team.
- The resistance loads provided by this technical data manual are valid only for exact same masonry unit (hollow bricks) or for units made of the same base material with equal or higher size and compressive strength (solid bricks). For other cases, on-site tests must be performed-please consult page 8.

Exterior brick dimensions

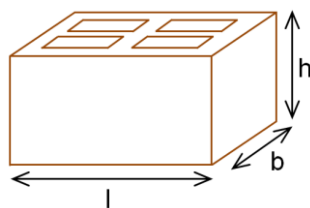

Generic bricks

Interior dimensions of the majority of the holes

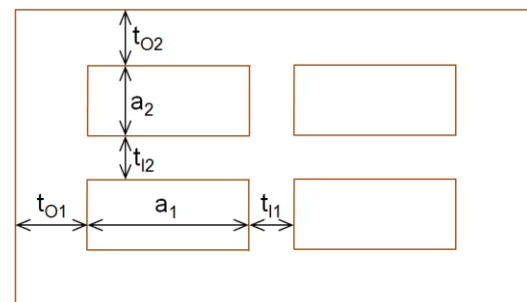

Brick types and properties

Brick code	Data	Brick name	Image	Size [mm]	t_0 [mm]	t_1 [mm]	a [mm]	f_b [N/mm ²]	ρ [kg/dm ³]	Page
Solid Clay										
SC	ETA	Solid clay brick Mz, 2DF		l: ≥ 240 b: ≥ 115 h: ≥ 113	-	-	-	12	2,0	17
Hollow Clay										
HC	ETA	Hollow clay brick Hz, 10DF		l: 300 b: 240 h: 238	$t_{01}:12$ $t_{02}:15$	$t_{11}:11$ $t_{12}:15$	$a_1: 10$ $a_2: 25$	12/20	1,4	17
Solid Calcium Silicate										
SCS	ETA	Solid silica brick KS, 2DF		l: ≥ 240 b: ≥ 115 h: ≥ 113	-	-	-	12/28	2,0	17
Hollow Calcium Silicate										
HCS	ETA	Hollow silica brick KSL, 8DF		l: 248 b: 240 h: 238	$t_{01}:34$ $t_{02}:21$	$t_{11}:12$ $t_{12}:30$	$a_1: 50$ $a_2: 50$	12/20	1,4	17
Hollow lightweight concrete										
HLWC	ETA	Hollow lightweight concrete brick		l: 495 b: 240 h: 238	$t_{01}:45$ $t_{02}:51$	$t_{11}:35$ $t_{12}:36$	$a_1:196$ $a_2: 52$	2/6	0,8	18
Hollow normal weight concrete										
HNWC	ETA	Hollow normal weight concrete brick		l: 500 b: 200 h: 200	$t_{01}:30$ $t_{02}:15$	$t_{11}:15$ $t_{12}:15$	$a_1:133$ $a_2: 75$	4/10	1,0	18

Anchor installation parameters

Brick position:

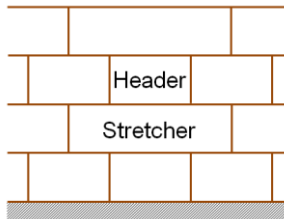

- **Header (H):** The longest dimension of the brick represents the width of the wall
- **Stretcher (S):** The longest dimension of the brick represents the length of the wall

Spacing and edge distance:

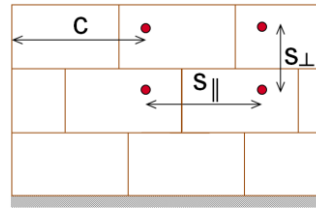

- c - Distance to the edge
- s_{||} - Spacing parallel to the horizontal joint
- s_⊥ - Spacing perpendicular to the horizontal joint

Minimum and characteristic spacing and edge distance parameters

- c_{min} - Minimum edge distance
- c_{cr} - Characteristic edge distance
- s_{min ||} - Min. spacing distance parallel to the bed joint
- s_{cr ||} - Characteristic spacing distance parallel to the bed joint
- s_{min ⊥} - Min. spacing distance perpendicular to the bed joint
- s_{cr ⊥} - Characteristic spacing distance perpendicular to the bed joint

Allowed anchor positions:

$$c \geq c_{cr} = c_{min}$$



$$c \geq c_{cr} = c_{min}$$

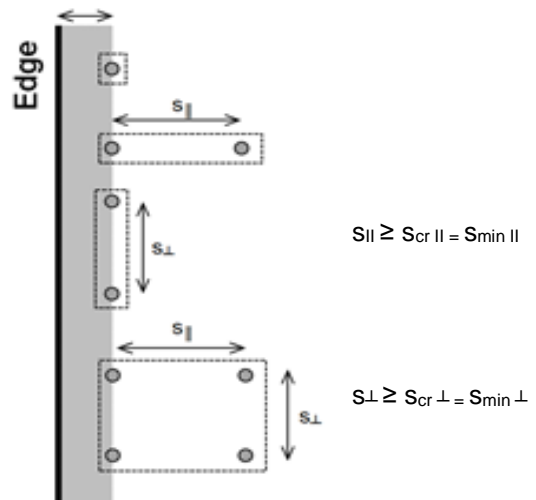

- This FTM includes the load data for single anchors in masonry with a distance to edge equal to or greater than the characteristic edge distance.

$$s_{||} \geq s_{cr ||} = s_{min ||}$$

$$s_{\perp} \geq s_{cr \perp} = s_{min \perp}$$

Edge and spacing distances per brick

Brick code	$c_{min} = c_{cr}$ [mm]	$s_{min } = s_{cr }$ [mm]	$s_{min\perp} = s_{cr\perp}$ [mm]
SC	115	240	115
HC	150	300	240
SCS	115	240	115
HCS	125	248	240
HLC	250	240	240
HNC	200	200	200

Anchor dimensions

Anchor size		M8	M10	M12
Embedment depth	HIT-V-(R, HCR) h_{ef} [mm]	80		
Embedment depth	HIT-IT h_{ef} [mm]	80		

Design

- Anchorages are designed under the responsibility of an engineer experienced in anchorages and masonry work.
- Verifiable calculation notes and drawings are prepared taking account of the loads to be anchored. The position of the anchor is indicated on the design drawings (e.g. position of the anchor relative to supports, etc.).
- Anchorages under static or quasi-static loading are designed in accordance with: ETAG 029, Annex C, Design method A.

Basic loading data (for a single anchor)

The load tables provide the design resistance load for a single loaded anchor.

All data in this section applies to:

- Edge distance $c \geq c_{cr} = c_{min}$.
- Correct anchor setting (see instruction for use, setting details)

Anchorages subject to:		Hilti HIT-HY 170 with HIT-V or HIT-IC	
Masonry		in solid bricks	in hollow bricks
Hole drilling		hammer mode	rotary mode
Use category: dry or wet structure		Category d/d - Installation and use in structures subject to dry internal conditions. Category w/d - Installation in dry or wet substrate and use in structures subject to dry , internal conditions. Category w/w - Installation and use in structures subject to dry or wet environmental conditions.	
Installation direction		horizontal	
Use category		b (solid masonry)	c (hollow or perforated masonry)
Temperature in the base material at installation		+5° C to +40° C	-5° C to +40° C
In-service temperature	Temperature range Ta:	-40 °C to +40°C	(max. long term temperature +24°C and max. short term temperature +40 °C)
	Temperature range Tb:	-40 °C to +80°C	(max. long term temperature +50°C and max. short term temperature +80 °C)



Tension loading

The design tensile resistance is the lower value of

- Steel resistance: $N_{Rd,s}$
- Pull-out of the anchor: $N_{Rd,p}$
- Brick breakout failure: $N_{Rd,b}$
- Pull out of one brick $N_{Rd,pb}$

Shear loading

The design shear resistance is the lower value of

- Steel resistance: $V_{Rd,s}$
- Local brick failure: $V_{Rd,b}$
- Pushing out of one brick: $V_{Rd,pb}$

Design tension and shear resistances – Steel failure for HIT-V

Anchor size		M8	M10	M12
Tension $N_{Rd,s}$	HIT-V 5.8(F)	12,2	19,3	28,1
	HIT-V 8.8(F)	19,5	30,9	44,9
	HIT-V-R	13,7	21,7	31,6
	HIT-V-HCR	19,5	30,9	44,9
Shear $V_{Rd,s}$	HIT-V 5.8(F)	7,4	11,6	16,9
	HIT-V 8.8(F)	11,7	18,6	27,0
	HIT-V-R	8,2	13,0	18,9
	HIT-V-HCR	11,7	18,6	27,0
$M^0_{Rd,s}$	HIT-V 5.8(F)	15,0	29,9	52,4
	HIT-V 8.8(F)	24,0	47,8	83,8
	HIT-V-R	16,9	33,6	59,0
	HIT-V-HCR	24,0	47,8	83,8

Design tension and shear resistances – Steel failure for internally threaded sleeves HIT-IC

Anchor size		M8	M10	M12
Tension $N_{Rd,s}$	HIT-IC [kN]	3,9	4,8	9,1
Shear $V_{Rd,s}$	HIT-IC [kN]	7,4	11,6	16,9
	Screw 8.8 [kN]	11,7	18,6	27,0
$M^0_{Rd,s}$	HIT-IC [Nm]	15,0	29,9	52,4
	Screw 8.8 [Nm]	24,0	47,8	83,8

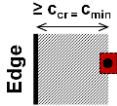

Design tension and shear resistances – Pull-out failure of the anchor, brick breakout failure and local brick failure at characteristic edge distance ($c \geq c_{cr} = c_{min}$) for single anchor applications

Load type	Anchor size	h_{ef} [mm]	f_b [N/mm ²]	w/w and w/d		d/d		
				Ta	Tb	Ta	Tb	
Loads [kN]								
SC - Solid clay brick Mz, 2DF								
$N_{Rd,p} = N_{Rd,b}$ ($c_{cr} = c_{min} = 115\text{mm}$)	HIT-V	M8, M10, M12	80	12	1,2	1,0	1,2	1,0
	HIT-IC	M8			1,2	1,0	1,2	1,0
	HIT-IC	M10, M12			1,6	1,4	1,6	1,4
	HIT-V + HIT-SC	M8, M10, M12			1,6	1,4	1,6	1,4
	HIT-IC + HIT-SC	M8, M10, M12			1,6	1,4	1,6	1,4
$V_{Rd,b}$ ($c_{cr} = c_{min} = 115\text{mm}$)	HIT-V	M8, M10, M12	80	12	1,4			
	HIT-V + HIT-SC	M8, M10, M12			1,4			
	HIT-IC	M8, M10, M12			1,4			
	HIT-IC + HIT-SC	M8, M10, M12			1,4			
HC - Hollow clay brick Hlz, 10DF								
$N_{Rd,p} = N_{Rd,b}$ ($c_{cr} = c_{min} = 150\text{mm}$)	HIT-V + HIT-SC	M8, M10, M12	80	12	1,2	1,0	1,2	1,0
	HIT-IC + HIT-SC	M8, M10, M12		20	1,4	1,2	1,4	1,2
$V_{Rd,b}$ ($c_{cr} = c_{min} = 150\text{mm}$)	HIT-V + HIT-SC	M8, M10, M12	80	12	0,8			
	HIT-IC + HIT-SC	M8, M10, M12		20	1,2			
SCS - Solid silica brick KS, 2DF								
$N_{Rd,p} = N_{Rd,b}$ ($c_{cr} = c_{min} = 115\text{mm}$)	HIT-V	M8, M10, M12	80	12	2,2	2,0	2,4	2,0
	HIT-IC	M8, M10, M12		28	3,4	3,0	3,4	3,0
	HIT-V + HIT-SC	M8, M10, M12		12	1,6	1,4	2,2	2,0
	HIT-IC + HIT-SC	M8, M10, M12		28	2,4	2,2	3,2	3,0
$V_{Rd,b}$ ($c_{cr} = c_{min} = 115\text{mm}$)	HIT-V	M8, M10, M12	80	12	1,6			
	HIT-V + HIT-SC	M8, M10, M12		28	2,4			
	HIT-IC	M8, M10, M12			2,4			
$V_{Rd,b}$ ($c_{cr} = c_{min} = 115\text{mm}$)	HIT-IC + HIT-SC	M8, M10, M12	80	12	1,6			
	HIT-IC + HIT-SC	M8, M10, M12		28	2,4			
HCS - Hollow silica brick KSL, 8DF								
$N_{Rd,p} = N_{Rd,b}$ ($c_{cr} = c_{min} = 125\text{mm}$)	HIT-V + HIT-SC	M8, M10, M12	80	12	1,2	1,0	1,4	1,2
	HIT-IC + HIT-SC	M8, M10, M12		20	1,6	1,4	2,0	1,8
$V_{Rd,b}$ ($c_{cr} = c_{min} = 125\text{mm}$)	HIT-V + HIT-SC	M8, M10, M12	80	12	3,4			
	HIT-IC + HIT-SC	M8, M10, M12		20	4,8			

Load type	Anchor size	h_{ef} [mm]	f_b [N/mm ²]	w/w and w/d		d/d		
				Ta	Tb	Ta	Tb	
Loads [kN]								
HLWC – Hollow lightweight concrete brick HBL, 16DF								
$N_{Rd,p} = N_{Rd,b}$ ($C_{cr} = C_{min} = 250$ mm)	HIT-V + HIT-SC	M8, M10, M12	80	2	0,5	0,4	0,6	0,5
	HIT-IC + HIT-SC	M8, M10, M12		6	0,8	0,6	1,0	0,8
$V_{Rd,b}$ ($C_{cr} = C_{min} = 250$ mm)	HIT-V + HIT-SC	M8, M10, M12	80	2	1,0			
	HIT-IC + HIT-SC	M8, M10, M12		6	1,6			
HNWC – Hollow normal weight concrete brick Parpaing creux								
$N_{Rd,p} = N_{Rd,b}$ ($C_{cr} = C_{min} = 200$ mm)	HIT-V + HIT-SC	M8, M10, M12	80	4	0,4			
	HIT-IC + HIT-SC	M8, M10, M12		10	0,5	0,6		
$V_{Rd,b}$ ($C_{cr} = C_{min} = 200$ mm)	HIT-V + HIT-SC	M8, M10, M12	80	4	1,0			
	HIT-IC + HIT-SC	M8, M10, M12		10	1,6			

Design tension and shear resistances – Pull out and pushing out of one brick failures

Pull out of one brick (tension):

$$N_{Rd,pb} = 2 \cdot l \cdot b \cdot (0,5 \cdot f_{vko} + 0,4 \cdot \sigma_d) / (2,5 \cdot 1000) \text{ [kN]}$$

$$N_{Rd,pb}^* = (2 \cdot l \cdot b \cdot (0,5 \cdot f_{vko} + 0,4 \cdot \sigma_d) + b \cdot h \cdot f_{vko}) / (2,5 \cdot 1000) \text{ [kN]}$$

* this equation is applicable if the vertical joints are filled

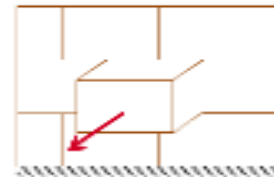

Pushing out of one brick (shear):

$$V_{Rd,pb} = 2 \cdot l \cdot b \cdot (0,5 \cdot f_{vko} + 0,4 \cdot \sigma_d) / (2,5 \cdot 1000) \text{ [kN]}$$

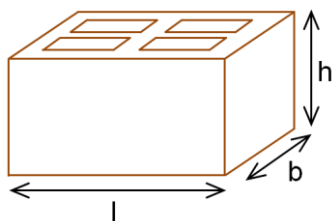
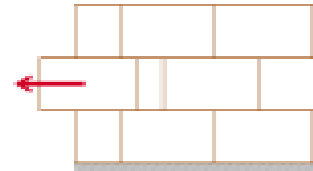

σ_d = design compressive stress perpendicular to the shear (N/mm²)
 f_{vko} = initial shear strength according to EN 1996-1-1, Table 3.4

Brick type	Mortar strength	f_{vko} [N/mm ²]
Clay brick	M2,5 to M9	0,20
	M10 to M20	0,30
All other types	M2,5 to M9	0,15
	M10 to M20	0,20

On-site test



For other bricks in solid or hollow masonry, not covered by the Hilti HIT-HY 170 ETA or this technical data manual, the characteristic resistance may be determined by on-site tension tests (pull-out tests or proof-load tests), according to ETAG029, Annex B.

For the evaluation of test results, the characteristic resistance shall be obtained taking into account the β factor, which considers the different influences of the product.

The β factor for the brick types covered by the Hilti HIT-HY 170 ETA is provided in the following table:

Use categories		w/w and w/d		d/d	
Temperature range		Ta*	Tb*	Ta*	Tb*
Base material	Elements				
Solid clay brick	HIT-V or HIT-IC	0,97	0,83	0,97	0,83
	HIT-V + HIT-SC				
	HIT-IC + HIT-SC				
Solid calcium silicate brick	HIT-V or HIT-IC	0,96	0,84	0,97	0,84
	HIT-V + HIT-SC	0,69	0,62	0,91	0,82
	HIT-IC + HIT-SC				
Hollow clay brick	HIT-V + HIT-SC	0,97	0,83	0,97	0,83
	HIT-IC + HIT-SC				
Hollow calcium silicate brick	HIT-V + HIT-SC	0,69	0,62	0,91	0,82
	HIT-IC + HIT-SC				
Hollow lightweight concrete brick	HIT-V + HIT-SC	0,89	0,81	0,97	0,86
	HIT-IC + HIT-SC				
Hollow normal weight concrete brick	HIT-V + HIT-SC	0,97	0,80	0,97	0,80
	HIT-IC + HIT-SC				

*Ta / Tb, w/w and d/d anchorage parameters, as defined on Tables pages 8-9

Applying the β factor from the table above, the characteristic tension resistance N_{Rk} can be obtained. Characteristic shear resistance V_{Rk} can also be directly derived from N_{Rk} . For detailed procedure consult ETAG 029, Annex B.

Materials

Material quality

Part	Material
Threaded rod HIT-V 5.8 (F)	Strength class 5.8, A5 > 8% ductile Steel galvanized $\geq 5\mu\text{m}$; (F) Hot dip galvanized $\geq 45\mu\text{m}$
Threaded rod HIT-V 8.8 (F)	Strength class 8.8, A5 > 8% ductile Steel galvanized $\geq 5\mu\text{m}$; (F) Hot dip galvanized $\geq 45\mu\text{m}$
Threaded rod HIT-V-R	Strength class 70 for $\leq M24$ and class 50 for $> M24$, A5 > 8% ductile Stainless steel 1.4401; 1.4404; 1.4578; 1.4571; 1.4439; 1.4362
Threaded rod HIT-V-HCR	A5 > 8% ductile High corrosion resistant steel 1.4528, 1.4565
Internally threaded sleeve HIT-IC	A5 > 8% ductile Electroplated zinc coated $\geq 5\mu\text{m}$
Washer	Steel galvanized
	Stainless steel 1.4401; 1.4404; 1.4578; 1.4571; 1.4439; 1.4362
	High corrosion resistant steel 1.4529, 1.4565 EN 10088
Hexagon nut	Strength class 8 Electroplated zinc coated $\geq 5\mu\text{m}$ Hot dip galvanized $\geq 45\mu\text{m}$
	Strength class 70 Stainless steel grade A4 1.4401; 1.4404; 1.4578; 1.4571; 1.4439; 1.4362
	Strength class 70, high corrosion resistant steel, 1.4529; 1.4565
Internally threaded sleeve HIT-IC	A5 > 8% ductile Electroplated zinc coated $\geq 5\mu\text{m}$
Sieve sleeve HIT-SC	Frame: Polyfort FPP 20T Sieve: PA6.6 N500/200

Base materials:

- Solid brick masonry. The characteristic resistances are also valid for larger brick sizes and larger compressive strengths of the masonry unit.
- Hollow brick masonry
- Mortar strength class of the masonry: M2,5 at minimum according to EN 998-2: 2010.
- For other bricks in solid masonry and in hollow or perforated masonry, the characteristic resistance of the anchor may be determined by on-site tests according to ETAG 029, Annex B under consideration of the β -factor according to Table page 9.

Setting information

Installation temperature range:

-5°C to +40°C

In service temperature range

Hilti HIT-HY 170 injection mortar may be applied in the temperature ranges given below. An elevated base material temperature may lead to a reduction of the design bond resistance.

Temperature range	Base material temperature	Max. long term base material temperature	Max. short term base material temperature
Temperature range I	-40 °C to + 40 °C	+ 24 °C	+ 40 °C
Temperature range II	-40 °C to + 80 °C	+ 50 °C	+ 80 °C

Max. short term base material temperature

Short term elevated base material temperatures are those that occur over brief intervals, e.g. as a result of diurnal cycling.

Max. long term base material temperature

Long term elevated base material temperatures are roughly constant over significant periods of time.

Working time and curing time

Temperature of the base material	Maximum working time t_{work}	Minimum curing time t_{cure}
$-5\text{ °C} \leq T_{BM} \leq 0\text{ °C}$ ^{a)}	10 min	12 h
$0\text{ °C} \leq T_{BM} \leq 5\text{ °C}$ ^{a)}	10 min	5 h
$5\text{ °C} \leq T_{BM} \leq 10\text{ °C}$	8 min	2,5 h
$10\text{ °C} \leq T_{BM} \leq 20\text{ °C}$	5 min	1,5 h
$20\text{ °C} \leq T_{BM} \leq 30\text{ °C}$	3 min	45 min
$30\text{ °C} \leq T_{BM} \leq 40\text{ °C}$	2 min	30 min

The curing time data are valid for dry base material only. In wet base material the curing times must be doubled.

a) Data valid for hollow bricks only

Installation Parameters

Single sieve sleeve, $50\text{mm} > h_{ef} > 80\text{mm}$

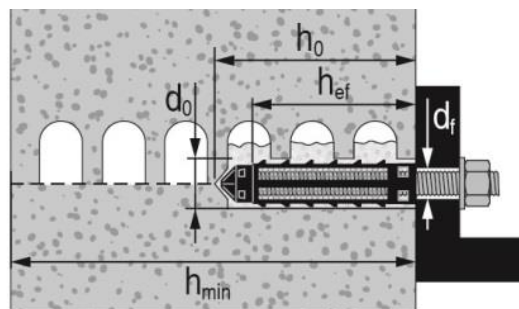

Installation parameters of HIT-V with sieve sleeve HIT-SC in hollow and solid brick

Threaded rods and HIT-V		M8	M10	M12
with HIT-SC		16x85		18x85
Nominal diameter of drill bit	d_0 [mm]	16	16	18
Drill hole depth	h_0 [mm]	95	95	95
Effective embedment depth	h_{ef} [mm]	80	80	80
Maximum diameter of clearance hole in the fixture	d_f [mm]	9	12	14
Minimum wall thickness	h_{min} [mm]	115	115	115
Brush HIT-RB		16	16	18
Number of strokes HDM		6	6	8
Number of strokes HDE 500-		5	5	6
Maximum torque moment for all brick types except "parpaing creux"	T_{max} [Nm]	3	4	6
Maximum torque moment for "parpaing creux"	T_{max} [Nm]	2	2	3

Installation parameters of HIT-IC with HIT-SC in hollow and solid brick

HIT-IC		M8	M10	M12
with HIT-SC		16x85	18x85	22x85
Nominal diameter of drill bit	d_0 [mm]	16	18	22
Drill hole depth	h_0 [mm]	95	95	95
Effective embedment depth	h_{ef} [mm]	80	80	80
Thread engagement length	h_s [mm]	8...75	10...75	12...75
Maximum diameter of clearance hole in the fixture	d_f [mm]	9	12	14
Minimum wall thickness	h_{min} [mm]	115	115	115
Brush HIT-RB		16	18	22
Number of strokes HDM		6	8	10
Number of strokes HDE-500		5	6	8
Maximum torque moment	T_{max} [Nm]	3	4	6

Solid bricks without sieve sleeves ^{a)}

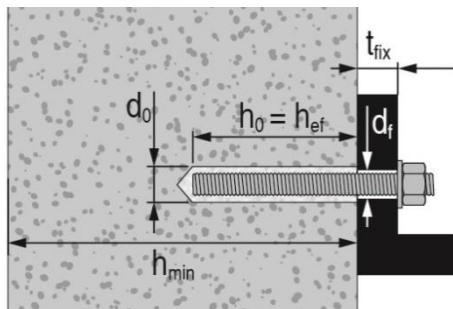

Installation parameters of HIT-V in solid bricks

Threaded rods and HIT-V		M8	M10	M12
Nominal diameter of drill bit	d_0 [mm]	10	12	14
Drill hole depth = Effective embedment depth	$h_0 = h_{ef}$ [mm]	50...300	50...300	50...300
Maximum diameter of clearance hole in the fixture	d_f [mm]	9	12	14
Minimum wall thickness	h_{min} [mm]	h_0+30	h_0+30	h_0+30
Brush HIT-RB		10	12	14
Maximum torque moment	T_{max} [Nm]	5	8	10

a) Hilti recommends the anchoring in masonry always with sieve sleeve. Anchors can only be installed without sieve sleeves in solid bricks when it is guaranteed that it has not any hole or void.

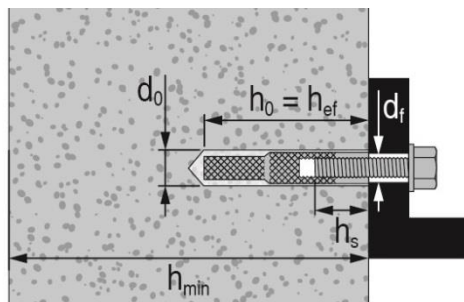

Installation parameters of HIT-IC in solid bricks







HIT-IC		M8x80	M10x80	M12x80
Nominal diameter of drill bit	d_0 [mm]	14	16	18
Drill hole depth = Effective embedment depth	$h_0 = h_{ef}$ [mm]	80	80	80
Thread engagement length	h_s [mm]	8...75	10...75	12...75
Maximum diameter of clearance hole in the fixture	d_f [mm]	9	12	14
Minimum wall thickness	h_{min} [mm]	115	115	115
Brush HIT-RB		14	16	18
Maximum torque moment	T_{max} [Nm]	5	8	10

a) Hilti recommends the anchoring in masonry always with sieve sleeve. Anchors can only be installed without sieve sleeves in solid bricks when it is guaranteed that it has not any hole or void.

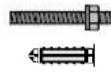
Installation equipment

Anchor size	M8	M10	M12
Rotary hammer	TE2(A) – TE30(A)		
Other tools	compressed air gun or blow out pump, set of cleaning brushes, dispenser		

Drilling and cleaning parameters

HIT-V ^{a)}	HIT-V + sieve sleeve	HIT-IC ^{a)}	HIT-IC + sieve sleeve	Hammer drill	Brush HIT-RB	Piston plug HIT-SZ
				d_0 [mm]	size [mm]	
						
M8	-	-	-	10	10	-
M10	-	-	-	12	12	12
M12	-	M8	-	14	14	14
-	M8	-	-	16	16	16
-	M10	M10	M8	16	16	16
-	M12	M12	M10	18	18	18
-	-	-	M12	22	22	22

a) Installation without the sieve sleeve HIT-SC can be used only in case of solid bricks.

Setting instructions

*For detailed information on installation see instruction for use given with the package of the product.



Safety regulations.

Review the Material Safety Data Sheet (MSDS) before use for proper and safe handling! Wear well-fitting protective goggles and protective gloves when working with Hilti HIT-HY 170.

Drilling

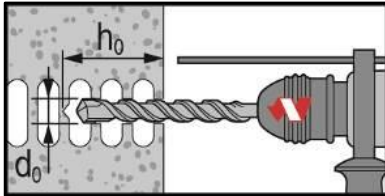

In hollow bricks: rotary mode

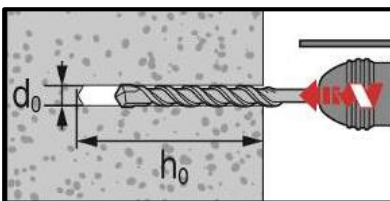

In solid bricks: hammer mode

Cleaning

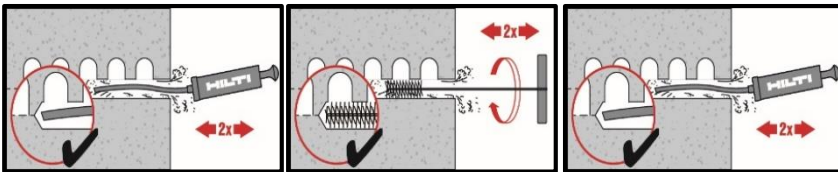

Manual cleaning (MC)

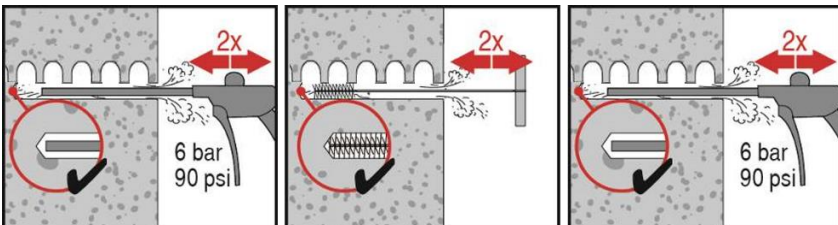

Compressed air cleaning (CAC)

Instructions for solid bricks without sieve sleeve

Injection system

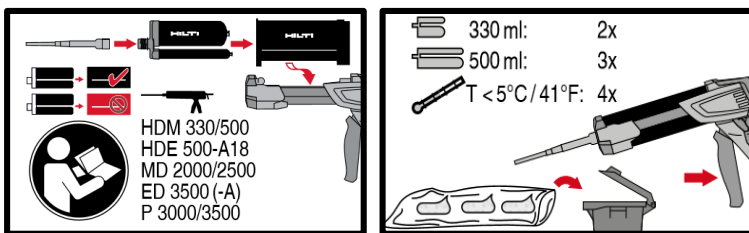

Injection system preparation.

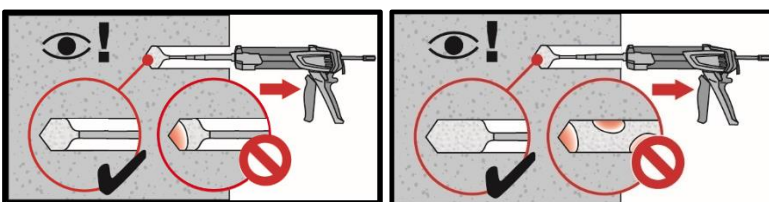

Injection method for drill hole

Setting the element

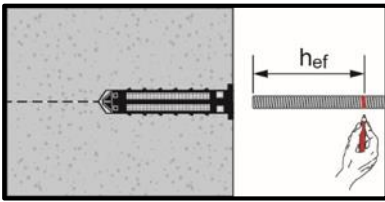

Presetting element, observe working time “ t_{work} ”,

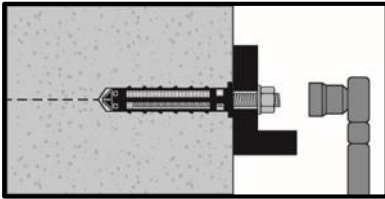

Loading the anchor: After required curing time t_{cure} the anchor can be loaded.

Instructions for hollow and solid bricks with sieve sleeve

Preparation of the sieve sleeve

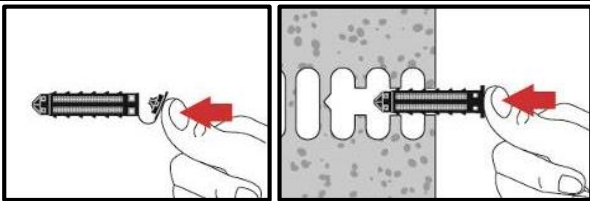

Close lid and insert sieve sleeve manually

Injection system

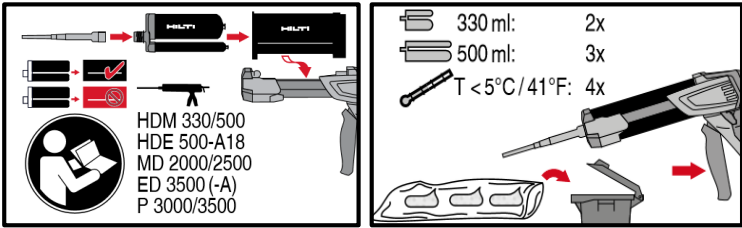

Injection system preparation.

Injection system: hollow bricks

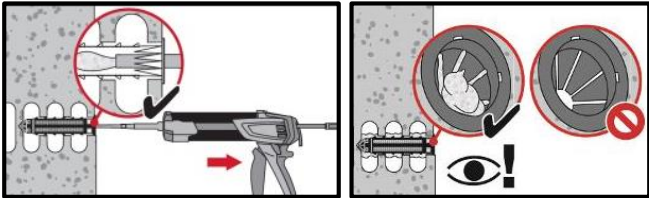

Installation with sieve sleeve HIT-SC

Setting the element

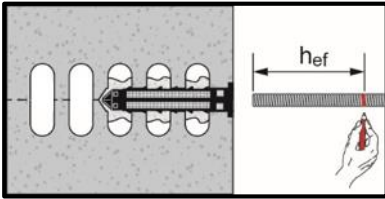

Presetting element, observe working time “ t_{work} ”,

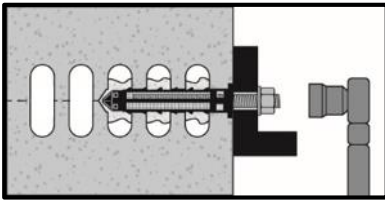



Loading the anchor: After required curing time t_{cure} the anchor can be loaded.



HIT-HY 170 injection mortar

Anchor design (EN 1992-4) / Rebar elements / Concrete

Injection mortar system	Benefits
 <p>Hilti HIT-HY 170 500 ml foil pack (also available as 330 ml foil pack)</p>	<ul style="list-style-type: none"> - Suitable for non-cracked and cracked concrete C 12/15 to C 50/60 - Suitable for dry and water saturated concrete - High loading capacity and fast cure - In service temperature range up to 80°C short term/50°C long term
 <p>Rebar B500 B ($\phi 8$-$\phi 25$)</p>	<ul style="list-style-type: none"> - Manual cleaning for drill hole sizes ≤ 18 mm and embedment depth $h_{ef} \leq 10d$

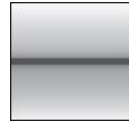
Base material	Load conditions
 <p>Concrete (non-cracked)</p>  <p>Dry concrete</p>  <p>Wet concrete</p>	 <p>Static/ quasi-static</p>

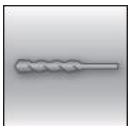
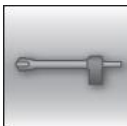
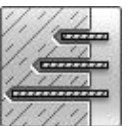
Installation conditions	Other information
 <p>Hammer drilling</p>  <p>Hollow drill-bit drilling</p>  <p>Variable embedment depth</p>	

Approvals / certificates

Description	Authority / Laboratory	No. / date of issue
Hilti Technical Data ^{a)}	Hilti	2017-11-28

a) All data given in this section according to Hilti Technical Data.

Static and quasi-static loading (for a single anchor)

All data in this section applies to

- Correct setting
- No edge distance and spacing influence
- Steel failure
- Base material thickness, as specified in the table
- One typical embedment depth, as specified in the table
- One anchor material, as specified in the tables
- Concrete C 20/25, $f_{ck,cube} = 25 \text{ N/mm}^2$
- Temperature range I
(min. base material temperature -40°C , max. long term/short term base material temperature: $+50^\circ\text{C}/80^\circ\text{C}$)

Embedment depth ^{a)} and base material thickness for static and quasi-static loading data

Anchor- size	$\phi 8$	$\phi 10$	$\phi 12$	$\phi 14$	$\phi 16$	$\phi 18$	$\phi 20$	$\phi 22$	$\phi 24$	$\phi 25$
Typical embedment depth [mm]	80	90	110	125	145	155	170	185	200	210
Base material thickness [mm]	110	120	140	161	185	199	220	237	256	274

a) The allowed range of embedment depth is shown in the setting details. The corresponding load values can be calculated according to the simplified design method.

Characteristic resistance

Anchor- size	$\phi 8$	$\phi 10$	$\phi 12$	$\phi 14$	$\phi 16$	$\phi 18$	$\phi 20$	$\phi 22$	$\phi 24$	$\phi 25$
Tensile N_{Rk}	20,1	28,3	41,5	58,9	72,9	87,7	106,8	127,1	142,8	153,7
Shear V_{Rk}	14,0	22,0	31,0	42,0	55,0	70,0	86,0	104,0	124,0	135,0

Design resistance

Anchor- size	$\phi 8$	$\phi 10$	$\phi 12$	$\phi 14$	$\phi 16$	$\phi 18$	$\phi 20$	$\phi 22$	$\phi 24$	$\phi 25$
Tensile N_{Rd}	13,4	18,8	27,6	39,3	48,6	58,4	71,2	84,7	95,2	102,5
Shear V_{Rd}	11,2	17,6	24,8	33,6	44,0	56,0	68,8	83,2	99,2	108,0

Recommended loads ^{a)}

Anchor- size	$\phi 8$	$\phi 10$	$\phi 12$	$\phi 14$	$\phi 16$	$\phi 18$	$\phi 20$	$\phi 22$	$\phi 24$	$\phi 25$
Tensile N_{Rec}	9,6	13,5	19,7	28,0	34,7	41,7	50,9	60,5	68,0	73,2
Shear V_{Rec}	8,0	12,6	17,7	24,0	31,4	40,0	49,1	59,4	70,9	77,1

a) With overall partial safety factor for action $\gamma = 1,4$. The partial safety factors for action depend on the type of loading and shall be taken from national regulations.

Materials

Mechanical properties

Anchor size	$\phi 8$	$\phi 10$	$\phi 12$	$\phi 14$	$\phi 16$	$\phi 18$	$\phi 20$	$\phi 22$	$\phi 24$	$\phi 25$
Nominal tensile strength f_{uk} [N/mm ²]	550	550	550	550	550	550	550	550	550	550
Yield strength f_{yk} [N/mm ²]	500	500	500	500	500	500	500	500	500	500
Stressed cross-section A_s [mm ²]	50,3	78,5	113,1	153,9	201,1	254,0	314,2	380	452	490,9
Moment of resistance W [mm ³]	50,3	98,2	169,6	269,4	402,1	572,6	785,4	1045,3	1357,2	1534



Material quality

Part	Material
Rebar EN 1992-1-1	Bars and de-coiled rods class B or C with f_{yk} and k according to NDP or NCL of EN 1992-1-1 $f_{uk} = f_{tk} = k \cdot f_{yk}$

Setting information

Installation temperature

-5°C to +40°C

Service temperature range

Hilti HIT-HY 170 injection mortar may be applied in the temperature ranges given below. An elevated base material temperature may lead to a reduction of the design bond resistance.

Temperature range	Base material temperature	Max. long term base material temperature	Max. short term base material temperature
Temperature range I	- 40 °C to + 40 °C	+ 24 °C	+ 40 °C
Temperature range II	- 40 °C to + 80 °C	+ 50 °C	+ 80 °C

Max. short term base material temperature

Short term elevated base material temperatures are those that occur over brief intervals, e.g. as a result of diurnal cycling.

Max. long term base material temperature

Long term elevated base material temperatures are roughly constant over significant periods of time.

Working time and curing time

Temperature of the base material	Max. working time in which rebar can be inserted and adjusted t_{work}	Min. curing time before rebar can be fully loaded t_{cure}
-5 °C ≤ T_{BM} ≤ 0 °C ^{a)}	10 min	12 h
0 °C ≤ T_{BM} ≤ 5 °C ^{a)}	10 min	5 h
5 °C ≤ T_{BM} ≤ 10 °C	8 min	2,5 h
10 °C ≤ T_{BM} ≤ 20 °C	5 min	1,5 h
20 °C ≤ T_{BM} ≤ 30 °C	3 min	45 min
30 °C ≤ T_{BM} ≤ 40 °C	2 min	30 min

The curing time data are valid for dry base material only. In wet base material the curing times must be doubled.

Installation equipment

Rebar – size	Ø8	Ø10	Ø12	Ø14	Ø16	Ø18	Ø20	Ø22	Ø24	Ø25
Rotary hammer	TE2(-A) – TE30(-A)					TE40 – TE80				
Other tools	Blow out pump or Compressed air gun ^{a)} Set of cleaning brushes ^{b)} , dispenser, piston plug									

a) Compressed air gun with extension hose for all drill holes deeper than 250 mm (for ϕ 8 to ϕ 12) or deeper than $20 \cdot \phi$ (for $\phi > 12$ mm)

b) Automatic brushing with round brush for all drill holes deeper than 250 mm (for ϕ 8 to ϕ 12) or deeper than $20 \cdot \phi$ (for $\phi > 12$ mm)

Setting details

Anchor size		Ø8	Ø10	Ø12		Ø14	Ø16	Ø18	Ø20	Ø22	Ø24	Ø25
Nominal diameter of drill bit	d_0 [mm]	10 / 12 ^{a)}	12 / 14 ^{a)}	14 ^{a)}	16 ^{a)}	18	20	22	25	26	28	32
Effective anchorage and drill hole depth range ^{b)}	$h_{ef,min}$ [mm]	60	60	70	70	75	80	85	90	95	100	100
	$h_{ef,max}$ [mm]	96	120	144	144	168	192	216	240	264	288	300
Minimum base material thickness	h_{min} [mm]	$h_{ef} + 30 \text{ mm}$ $\geq 100 \text{ mm}$				$h_{ef} + 2 d_0$						
Minimum spacing	s_{min} [mm]	40	50	60	60	70	80	90	100	110	120	125
Minimum edge distance	c_{min} [mm]	40	50	60	60	70	80	90	100	110	120	125
Critical spacing for splitting failure	$s_{cr,sp}$ [mm]	$2 c_{cr,sp}$										
Critical edge distance for splitting failure ^{c)}	$c_{cr,sp}$ [mm]	$1,0 \cdot h_{ef}$ for $h / h_{ef} \geq 2,0$										
		$4,6 h_{ef} - 1,8 h$ for $2,0 > h / h_{ef} > 1,3$										
		$2,26 h_{ef}$ for $h / h_{ef} \leq 1,3$										
Critical spacing for concrete cone failure	$s_{cr,N}$ [mm]	$2 c_{cr,N}$										
Critical edge distance for concrete cone failure ^{d)}	$c_{cr,N}$ [mm]	$1,5 h_{ef}$										

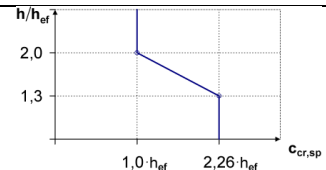

For spacing (edge distance) smaller than critical spacing (critical edge distance) the design loads have to be reduced.

- a) Both given values for drill bit diameter can be used
- b) $h_{ef,min} \leq h_{ef} \leq h_{ef,max}$ (h_{ef} : embedment depth)
- c) h : base material thickness ($h \geq h_{min}$)
- d) The critical edge distance for concrete cone failure depends on the embedment depth h_{ef} and the design bond resistance. The simplified formula given in this table is on the safe side.

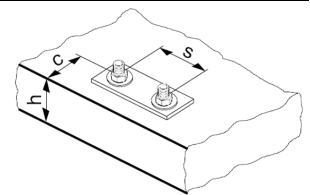

Drilling and cleaning parameters

Rebar	Drill bit diameters d_0 [mm]		Installation size [mm]	
	Hammer drill (HD)	Hollow Drill Bit (HDB)	Brush HIT-RB	Piston plug HIT-SZ
Ø8	10 / 12 ^{a)}	-	10 / 12 ^{a)}	- / 12
Ø10	12 / 14 ^{a)}	14	12 / 14 ^{a)}	12 / 14 ^{a)}
Ø12	14 / 16 ^{a)}	16 (14 ^{a)})	14 / 16 ^{a)}	14 / 16 ^{a)}
Ø14	18	18	18	18
Ø16	20	20	20	20
Ø18	22	22	22	22
Ø20	25	25	25	25
Ø22	28	28	28	28
Ø24	32	32	32	32
Ø25	32	32	32	32

- a) Each of the two given values can be used

Setting instructions

*For detailed information on installation see instruction for use given with the package of the product.



Safety regulations.

Review the Material Safety Data Sheet (MSDS) before use for proper and safe handling! Wear well-fitting protective goggles and protective gloves when working with Hilti HIT-HY 170.

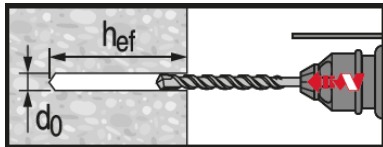

Hammer drilled hole

For dry and wet concrete.

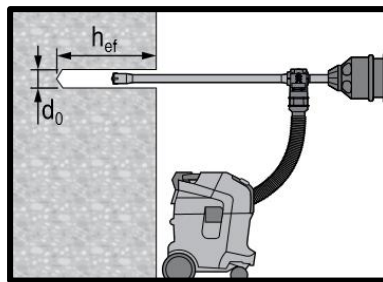

Hammer drilled hole with Hollow Drilled Bit (HDB)

No cleaning required.

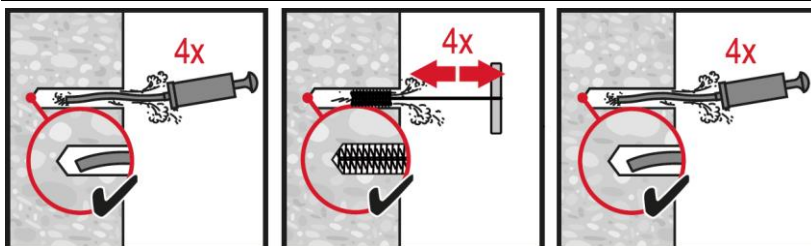

Manual cleaning (MC)

for drill diameters $d_0 \leq 20$ mm and drill hole depth $h_0 \leq 10 \cdot d$.

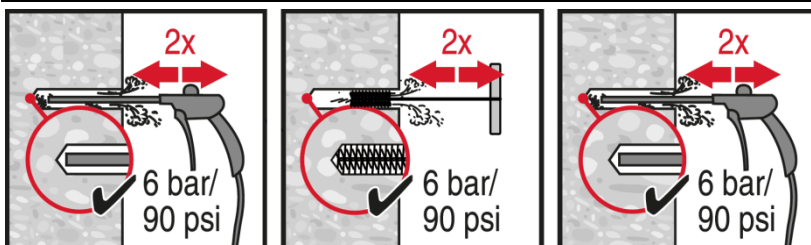

Compressed air cleaning (CAC)

for all drill hole diameters d_0 and drill hole depths $h_0 \leq 20 \cdot d$.

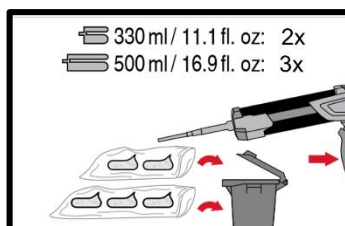
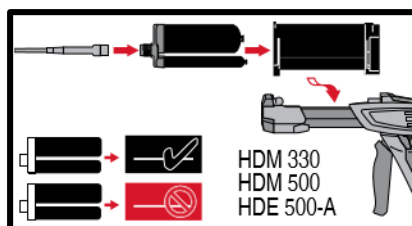

Injection system preparation.

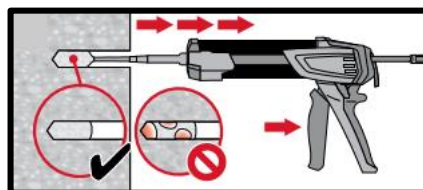
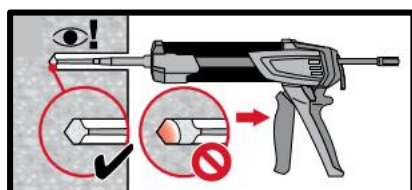

Injection method for drill hole depth

$h_{ef} \leq 250$ mm.

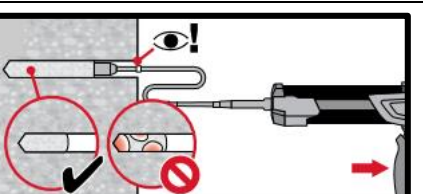
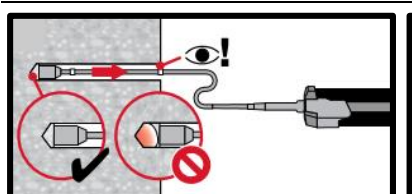

Injection method for drill hole depth

$h_{ef} > 250$ mm.

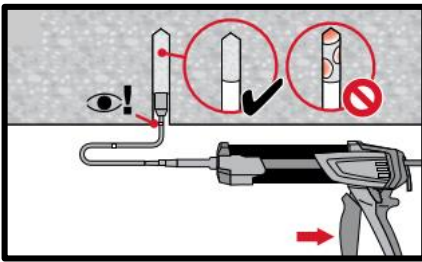
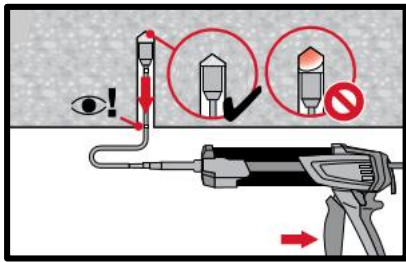

Injection method for overhead application.

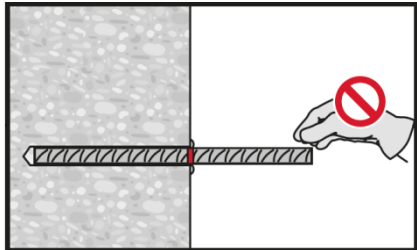
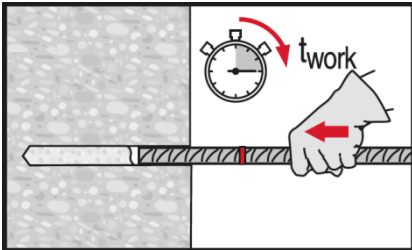

Setting element, observe working time " t_{work} ".

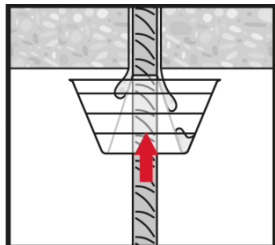
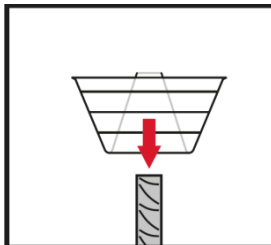
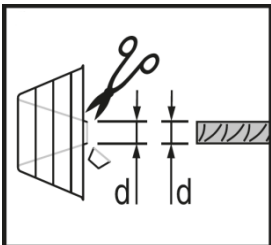

Setting element for overhead applications, observe working time " t_{work} ".

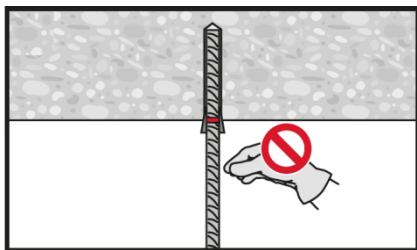
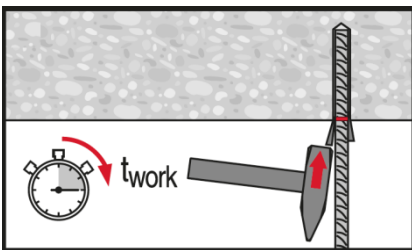







Loading the anchor: After required curing time t_{cure} the anchor can be loaded.



HIT-HY 170 injection mortar

Rebar design (EOTA TR023) / Rebar elements / Concrete

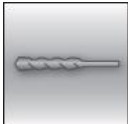
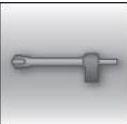
Injection mortar system	Benefits
 <p>Hilti HIT-HY 170 330 ml foil pack (also available as 500 ml foil pack)</p>	<ul style="list-style-type: none"> - Suitable for concrete C12/15 to C50/60 - Suitable for dry and water saturated concrete - High loading capacity and fast cure - High corrosion resistant - For rebar diameters up to 25 mm - Manual cleaning for drill hole sizes ≤ 20 mm and embedment depth $h_{ef} \leq 10d$ - Suitable for embedment depth up to 1000 mm depending on the rebar diameter
 <p>Rebar B500 B ($\phi 8 - \phi 25$)</p>	

Base material	Load conditions
<div style="display: flex; justify-content: space-around;"> <div style="text-align: center;">  <p>Concrete (Non-cracked)</p> </div> <div style="text-align: center;">  <p>Dry concrete</p> </div> <div style="text-align: center;">  <p>Water saturated concrete</p> </div> </div>	<div style="display: flex; justify-content: space-around;"> <div style="text-align: center;">  <p>Static/quasi- static</p> </div> <div style="text-align: center;">  <p>Fire resistance</p> </div> </div>
Installation conditions	Other informations
<div style="display: flex; justify-content: space-around;"> <div style="text-align: center;">  <p>Hammer drilled holes</p> </div> <div style="text-align: center;">  <p>Hollow drill- bit drilling</p> </div> </div>	<div style="display: flex; justify-content: space-around;"> <div style="text-align: center;">  <p>European Technical Assessment</p> </div> <div style="text-align: center;">  <p>CE conformity</p> </div> </div>

Approvals / certificates

Description	Authority / Laboratory	No. / date of issue
European Technical Assessment ^{a)}	DIBt, Berlin	ETA-15/0297 / 2015-12-11

b) All data given in this section according to ETA-15/0297 issue 2015-12-11.

Static and quasi-static loading

Design bond strength

Design bond strength in N/mm² accord. to ETA-15/0297 for good bond conditions

All allowed drilling methods									
Rebar - size	Concrete class								
	C12/15	C16/20	C20/25	C25/30	C30/37	C35/45	C40/50	C45/55	C50/60
φ8 - φ12	1,6	2,0	2,3	2,7	3,0	3,4	3,7	3,7	3,7
φ14 - φ25	1,6	2,0	2,3	2,7	3,0	3,4	3,4	3,4	3,4

For all other bond conditions multiply the values by 0,7.

Minimum anchorage length and minimum lap length

The minimum anchorage length $l_{b,min}$ and the minimum lap length $l_{0,min}$ according to EN 1992-1-1 shall be multiplied by the relevant **Amplification factor** α_{lb} in the table below.

Amplification factor α_{lb} for the min. anchorage length and min. lap length according to EN 1992-1-1 for:

All allowed drilling methods									
Rebar - size	Concrete class								
	C12/15	C16/20	C20/25	C25/30	C30/37	C35/45	C40/50	C45/55	C50/60
φ8 - φ25	1,0								

Pre-calculated values

Pre-calculated values¹⁾ – anchorage length

Rebar yield strength $f_{yk}=500$ N/mm², concrete C25/30, good bond conditions

Rebar [mm]	Anchorage length l_{bd} [mm]	Design value N_{Rd} [kN]	Mortar volume ²⁾ V_M [ml]	Anchorage length l_{bd} [mm]	Design value N_{Rd} [kN]	Mortar volume ²⁾ V_M [ml]
	$\alpha_1=\alpha_2=\alpha_3=\alpha_4=\alpha_5=1,0$			$\alpha_1 = \alpha_3 = \alpha_4 = 1,0 \quad \alpha_2 \text{ or } \alpha_5 = 0,7$		
φ8	100	6,8	8	100	9,7	8
	170	11,5	13	140	13,6	11
	250	17,0	19	180	17,4	14
	322	21,9	24	226	21,9	17
φ10	121	10,3	11	121	14,7	11
	220	18,7	20	170	20,6	15
	310	26,3	28	230	27,9	21
	403	34,2	36	281	34,1	25
φ12	145	14,8	15	145	21,1	15
	260	26,5	27	210	30,5	22
	370	37,7	39	270	39,3	29
	483	49,2	51	338	49,1	36
φ14	169	20,1	20	169	28,7	20
	300	35,6	36	240	40,7	29
	430	51,1	52	320	54,3	39
	564	67,0	68	394	66,8	48
φ16	193	26,2	26	193	37,4	26
	340	46,1	46	280	54,3	38
	490	66,5	67	370	71,7	50
	644	87,4	87	451	87,4	61
φ18	217	33,1	33	217	47,3	33
	380	58,0	57	310	67,6	47
	540	82,4	81	410	89,4	62
	700	106,9	106	507	110,6	76
φ20	242	41,1	51	242	58,6	51

Pre-calculated values¹⁾ – anchorage length

Rebar yield strength $f_{yk}=500 \text{ N/mm}^2$, concrete C25/30, good bond conditions

Rebar [mm]	Anchorage length l_{bd} [mm]	Design value N_{Rd} [kN]	Mortar volume ²⁾ V_M [ml]	Anchorage length l_{bd} [mm]	Design value N_{Rd} [kN]	Mortar volume ²⁾ V_M [ml]
	$\alpha_1=\alpha_2=\alpha_3=\alpha_4=\alpha_5=1,0$					
	390	66,2	83	350	84,8	74
	550	93,3	117	460	111,5	98
	700	118,8	148	564	136,7	120

$\phi 22$	266	49,6	75	266	70,9	75
	410	76,5	116	380	101,3	107
	560	104,5	158	500	133,3	141
	700	130,6	198	620	165,3	175
$\phi 24$	290	59,0	122	290	84,3	122
	430	87,5	182	420	122,1	177
	560	114,0	236	550	160,0	232
	700	142,5	296	676	196,6	285
$\phi 25$	302	64,0	114	302	91,5	114
	430	91,2	162	430	130,3	162
	570	120,9	214	570	172,7	214
	700	148,4	263	700	212,1	263

1) Values corresponding to the minimum anchorage length. The maximum permissible load is valid for "good bond conditions" as described in EN 1992-1-1. For all other conditions multiply by the value by 0,7.

2) The volume of mortar corresponds to the formula " $1,2 \cdot (d_0^2 - d_s^2) \cdot \pi \cdot l_b / 4$ " for hammer drilling

Pre-calculated values¹⁾ – overlap length

Rebar yield strength $f_{yk}=500 \text{ N/mm}^2$, concrete C25/30, good bond conditions

Rebar [mm]	Overlap length l_0 [mm]	Design value N_{Rd} [kN]	Mortar volume ²⁾ V_M [ml]	Overlap length l_0 [mm]	Design value N_{Rd} [kN]	Mortar volume ²⁾ V_M [ml]
	$\alpha_1=\alpha_2=\alpha_3=\alpha_4=\alpha_5=1,0$					
$\phi 8$	200	13,6	15	200	19,4	15
	240	16,3	18	210	20,4	16
	280	19,0	21	220	21,3	17
	322	21,9	24	226	21,9	17
$\phi 10$	200	17,0	18	200	24,2	18
	270	22,9	24	230	27,9	21
	340	28,8	31	250	30,3	23
	403	34,2	36	281	34,1	25
$\phi 12$	200	20,4	21	200	29,1	21
	290	29,5	31	250	36,4	26
	390	39,7	41	290	42,2	31
	483	49,2	51	338	49,1	36
$\phi 14$	210	24,9	25	210	35,6	25
	330	39,2	40	270	45,8	33
	450	53,4	54	330	56,0	40
	564	67,0	68	394	66,8	48
$\phi 16$	240	32,6	33	240	46,5	33
	370	50,2	50	310	60,1	42
	510	69,2	69	380	73,7	52
	644	87,4	87	451	87,4	61
$\phi 18$	270	41,2	41	270	58,9	41
	410	62,6	62	350	76,3	53
	560	85,5	84	430	93,8	65

Pre-calculated values¹⁾ – overlap length

Rebar yield strength $f_{yk}=500 \text{ N/mm}^2$, concrete C25/30, good bond conditions

Rebar [mm]	Overlap length l_0 [mm]	Design value N_{Rd} [kN]	Mortar volume ²⁾ V_M [ml]	Overlap length l_0 [mm]	Design value N_{Rd} [kN]	Mortar volume ²⁾ V_M [ml]
	$\alpha_1=\alpha_2=\alpha_3=\alpha_4=\alpha_5=1,0$				$\alpha_1 = \alpha_3 = \alpha_4 = 1,0 \quad \alpha_2 \text{ or } \alpha_5 = 0,7$	
	700	106,9	106	507	110,6	76
$\phi 20$	300	50,9	64	300	72,7	64
	430	72,9	91	390	94,5	83
	570	96,7	121	480	116,3	102
	700	118,8	148	564	136,7	120
$\phi 22$	330	61,6	93	330	88,0	93
	450	84,0	127	430	114,6	122
	580	108,2	164	520	138,6	147
	700	130,6	198	620	165,3	175
$\phi 24$	360	73,3	152	360	104,7	152
	470	95,7	198	470	136,7	198
	590	120,1	249	570	165,8	241
	700	142,5	296	676	196,6	285
$\phi 25$	375	79,5	141	375	113,6	141
	480	101,8	181	480	145,4	181
	590	125,1	222	590	178,7	222
	700	148,4	263	700	212,1	263

- 1) Values corresponding to the minimum anchorage length. The maximum permissible load is valid for "good bond conditions" as described in EN 1992-1-1. For all other conditions multiply by the value by 0,7.
- 2) The volume of mortar corresponds to the formula " $1,2 \cdot (d_0^2 - d_s^2) \cdot \pi \cdot l_b / 4$ " for hammer drilling

Materials

Material quality

Part	Material
Rebar EN 1992-1-1	Bars and de-coiled rods class B or C with f_{yk} and k according to NDP or NCL of EN 1992-1-1 $f_{uk} = f_{tk} = k \cdot f_{yk}$

Fitness for use

Some creep tests have been conducted in accordance with ETAG guideline 001 part 5 and TR 023 in the following conditions: **in dry environment at 50 °C during 90 days.**

These tests show an excellent behaviour of the post-installed connection made with HIT-HY 170: low displacements with long term stability, failure load after exposure above reference load.

Resistance to chemical substance

Chemical substance	Comment	Resistance
Sulphuric acid	23°C	+
Alkaline medium	pH = 13,2, 23°C	+

Installation temperature range

-5°C to +40°C

Service temperature range

Hilti HIT-HY 170 injection mortar may be applied in the temperature ranges given below. An elevated base material temperature may lead to a reduction of the design bond resistance.

Temperature range	Base material temperature	Maximum long term base material temperature	Maximum short term base material temperature

Temperature range I	-40 °C to +80 °C	+50 °C	+80 °C
---------------------	------------------	--------	--------

Max short term base material temperature

Short-term elevated base material temperatures are those that occur over brief intervals, e.g. as a result of diurnal cycling.

Max long term base material temperature

Long-term elevated base material temperatures are roughly constant over significant periods of time.

Working time and curing time

Temperature of the base material T_{BM}	Maximum working time t_{gel}	Minimum curing time $t_{cure}^{1)}$
$-5\text{ °C} \leq T_{BM} \leq 0\text{ °C}^a)$	10 min	12 hours
$0\text{ °C} \leq T_{BM} \leq 5\text{ °C}^a)$	10 min	5 hours
$5\text{ °C} \leq T_{BM} \leq 10\text{ °C}$	8 min	2,5 hours
$10\text{ °C} \leq T_{BM} \leq 20\text{ °C}$	5 min	1,5 hours
$20\text{ °C} \leq T_{BM} \leq 30\text{ °C}$	3 min	45 min
$30\text{ °C} \leq T_{BM} \leq 40\text{ °C}$	2 min	30 min

1) The curing time data are valid for dry base material only. In wet base material the curing times must be doubled.

Setting information

Installation equipment

Rebar – size	$\phi 8$	$\phi 10$	$\phi 12$	$\phi 14$	$\phi 16$	$\phi 18$	$\phi 20$	$\phi 22$	$\phi 24$	$\phi 25$
Rotary hammer	TE2(-A) – TE30(-A)					TE40 – TE80				
Other tools	Blow out pump ($h_{ef} \leq 10 \cdot d$)					Compressed air gun ^{a)} Set of cleaning brushes ^{b)} , dispenser, piston plug				

c) Compressed air gun with extension hose for all drill holes deeper than 250 mm (for $\phi 8$ to $\phi 12$) or deeper than $20 \cdot \phi$ (for $\phi > 12$ mm)

d) Automatic brushing with round brush for all drill holes deeper than 250 mm (for $\phi 8$ to $\phi 12$) or deeper than $20 \cdot \phi$ (for $\phi > 12$ mm)

Minimum concrete cover c_{min} of the post-installed rebar

Drilling method	Bar diameter [mm]	Minimum concrete cover c_{min} [mm]	
		Without drilling aid	With drilling aid
Hammer drilling (HD)	$\phi < 25$	$30 + 0,06 \cdot l_v \geq 2 \cdot \phi$	$30 + 0,02 \cdot l_v \geq 2 \cdot \phi$
	$\phi \geq 25$	$40 + 0,06 \cdot l_v \geq 2 \cdot \phi$	$40 + 0,02 \cdot l_v \geq 2 \cdot \phi$
Compressed air drilling (CA)	$\phi < 25$	$50 + 0,08 \cdot l_v$	$50 + 0,02 \cdot l_v$
	$\phi \geq 25$	$60 + 0,08 \cdot l_v \geq 2 \cdot \phi$	$60 + 0,02 \cdot l_v \geq 2 \cdot \phi$

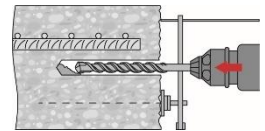





Drilling and cleaning parameters

Rebar	Hammer drilling (HD)	Compressed air drilling (CA)	Brush HIT-RB	Air nozzle HIT-RB
	d_0 [mm]		size [mm]	
$\phi 8$	10 ^{a)}	-	10	10
	12	-	12	12
$\phi 10$	12 ^{a)}	-	12	12
	14	-	14	14
$\phi 12$	14 ^{a)}	-	14	14
	16	-	16	16
	-	17	18	16

φ14	18	-	18	18
	-	17	18	16
φ16	20	20	20	20
φ18	22	22	22	22
φ20	25	-	25	25
	-	26	28	25
φ22	28	28	28	28
φ24	32	32	32	32
φ25	32	32	32	32

a) Maximum installation length $l=250$ mm.

Drilling and cleaning parameters

Rebar	Drill bit diameters d_0 [mm]		Installation size [mm]	
	Hammer drill (HD)	Hollow Drill Bit (HDB)	Brush HIT-RB	Piston plug HIT-SZ
				
$\phi 8$	10 / 12 ^{a)}	-	10 / 12 ^{a)}	- / 12
$\phi 10$	12 / 14 ^{a)}	14	12 / 14 ^{a)}	12 / 14 ^{a)}
$\phi 12$	14 / 16 ^{a)}	16 (14 ^{a)})	14 / 16 ^{a)}	14 / 16 ^{a)}
$\phi 14$	18	18	18	18
$\phi 16$	20	20	20	20
$\phi 18$	22	22	22	22
$\phi 20$	25	25	25	25
$\phi 22$	28	28	28	28
$\phi 24$	32	32	32	32
$\phi 25$	32	32	32	32

Dispensers and corresponding maximum embedment depth $l_{v,max}$

Rebar	Dispenser HDM 330, HDM 500, HDE 500
	$l_{v,max}$ [mm]
$\phi 8$ to $\phi 16$	1000
$\phi 18$ to $\phi 25$	700

Setting instructions

*For detailed information on installation see instruction for use given with the package of the product.



Safety regulations.

Review the Material Safety Data Sheet (MSDS) before use for proper and safe handling! Wear well-fitting protective goggles and protective gloves when working with Hilti HIT-HY 170.

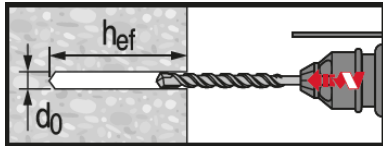

Hammer drilled hole

For dry and wet concrete.

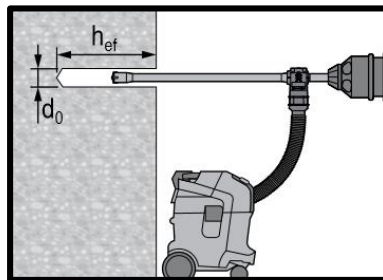

Hammer drilled hole with Hollow Drilled Bit (HDB)

No cleaning required.

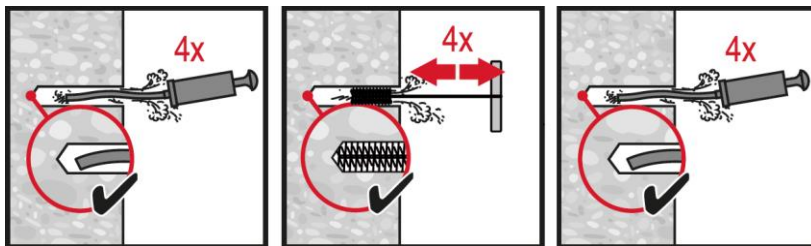

Manual cleaning (MC)

for drill diameters $d_0 \leq 20$ mm and drill hole depth $h_0 \leq 10 \cdot d$.

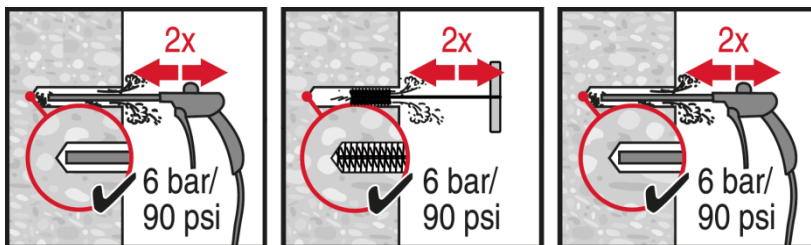

Compressed air cleaning (CAC)

for all drill hole diameters d_0 and drill hole depths $h_0 \leq 20 \cdot d$.

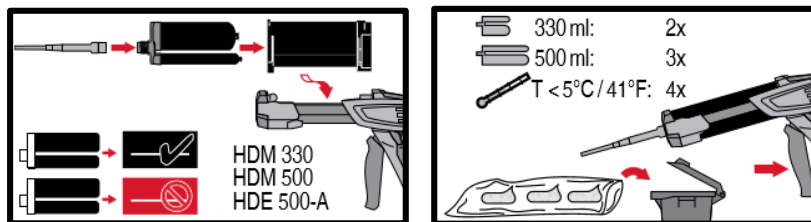

Injection system preparation.

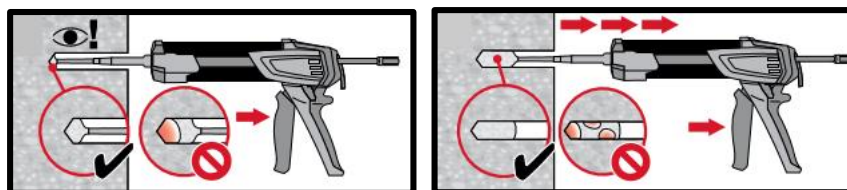

Injection method for drill hole depth $h_{ef} \leq 250$ mm.

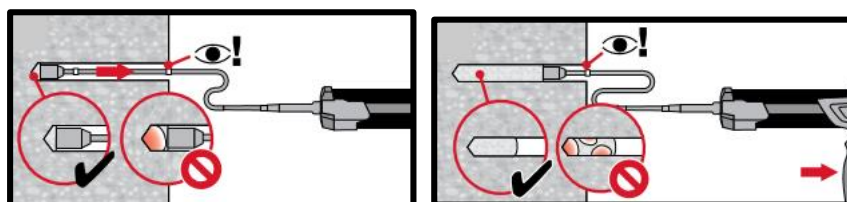

Injection method for drill hole depth $h_{ef} > 250$ mm.

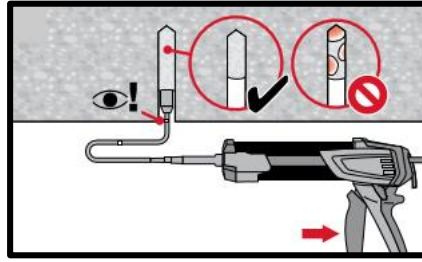
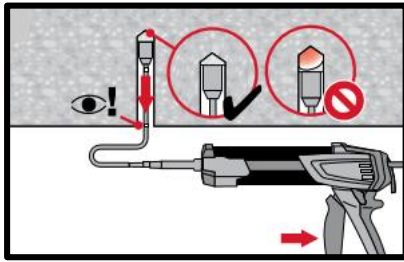

Injection method for overhead application.

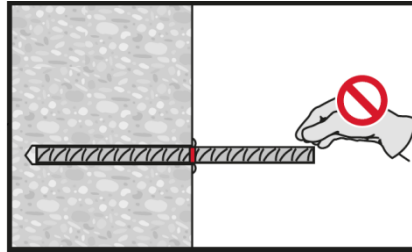
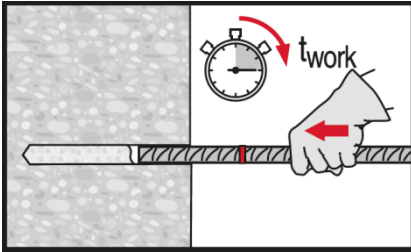

Setting element, observe working time "twork".

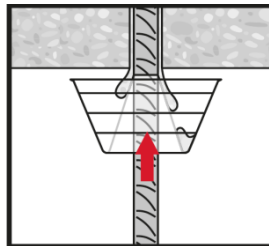
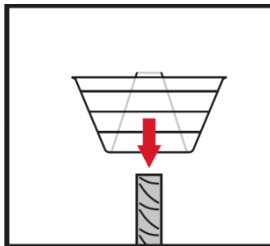
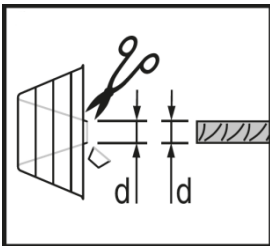

Setting element for overhead applications, observe working time "twork".

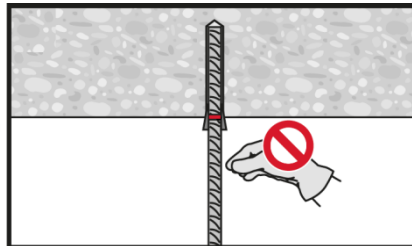
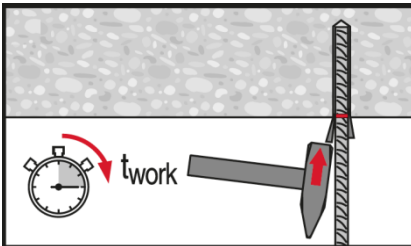

Apply full load only after curing time "tcure".

